

*Thank you for trusting Tekceleo and buying this piezoelectric motor.
Please follow the instructions below before using this WLG-30-R motor*

Inside the box

- WLG-30-R
- WLG-30 ECU
- US adapter plug
- 7,5V 2A Power Supply

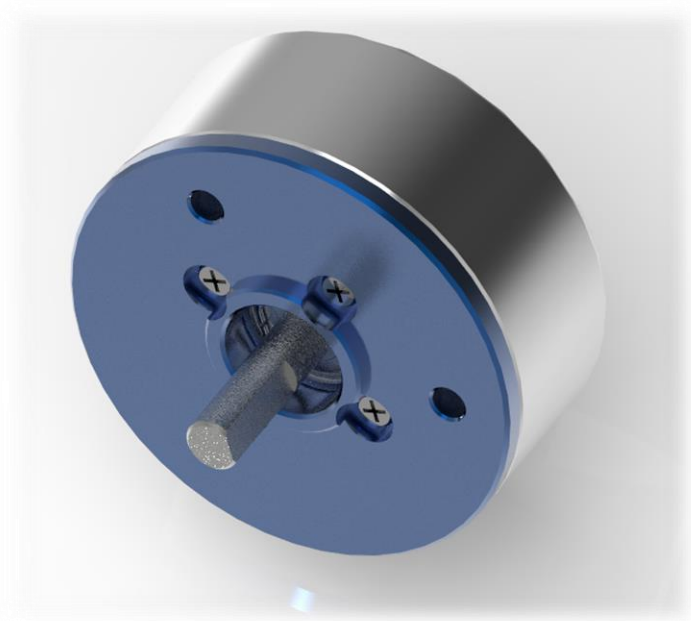

Power Up

Connect the power supply into an electrical outlet.

Motor Control

In order to turn on/ turn off the motor, activate the **on/off Switch (ON/OFF)**.
To change the direction of the rotation, activate the **CW/CCW Switch (DIRECTION)** (See figure 1).

Speed Control

In order to control the speed and turn on the motor, connect the ground pin 2 and the speed pin 1 to a voltage generator (See the figure 2 and 4). If the speed pin is not connected, the motor will not rotate.

Jumper Settings

In order to control the motor via the manual switches, place the jumpers in the **Switch Control** position (see figure 3).
In order to control the motor via pin 3 and 4, place the jumpers in the **External Control on pins 3 and 4 position** (see figure 3 and 4).

WLG-30-R with embedded encoder

Technical specifications

MOTOR DATA WITH EMBEDDED ENCODER	VALUES
Max No load speed	250 RPM
Stall torque	100 mN.m
Rated speed at maximum output	165 RPM
Rated torque at maximum output	75 mN.m
Holding torque	125 mN.m
Maximum power	1,3 W
Operating temperature	0°c to 60°c
MECHANICAL DATA	VALUES
Max radial load, 5mm from flange	10 N
Max axial load dynamics	2N
Max force for press fits (static, shaft supported)	80 N
Shaft concentricity	± 0,075 mm
Weight	37,7 g
Set WLG-30-R & ECU	VALUES
Maximal power consumption	7,5 VDC / 1,35A
Recommended power supply	7,5 VDC / 2A

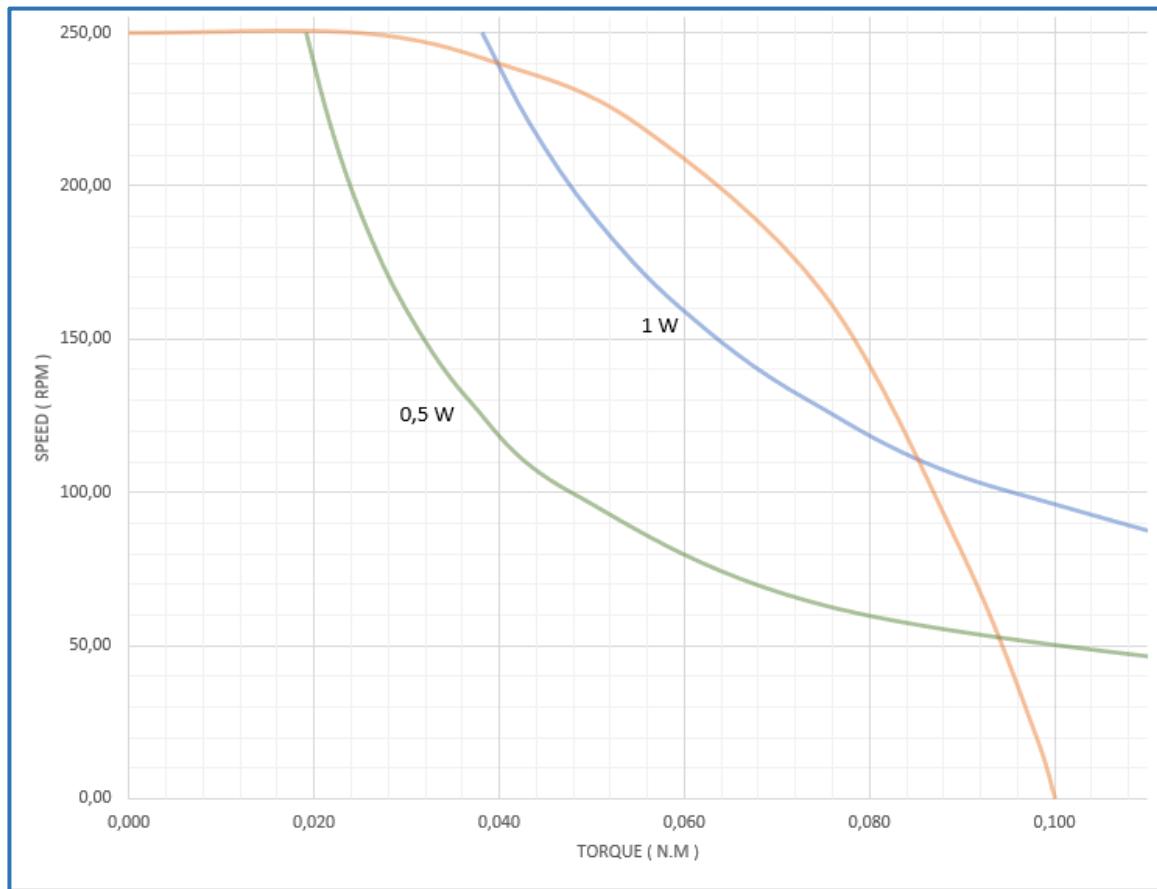

To operate continuously, the motor needs to dissipate heat. It is advisable to mount it on a metal cooling plate. Performances are ensured as long as the temperature of the motor remains under 40 degrees (see details page 5)

WLG-30-R with embedded encoder

Control specifications

CHARACTERISTICS	VALUES
On / Off response time (Pin 3)	< 500 μ s
Speed change response time	< 50 ms
Closed loop position controller (see figure below)	P control proportional
<u>In case you need to control the position of the motor :</u> In order to take advantage of the on / off response time of the motor, it is preferable to send a 0V on pin 3 once the motor has reached its position (see figure below)	
ENCODER DATA	VALUES
Two channel quadrature digital outputs for direction sensing : A and B	2000 increments per revolution each
One channel, Index digital output I (Z)	1 increment per revolution

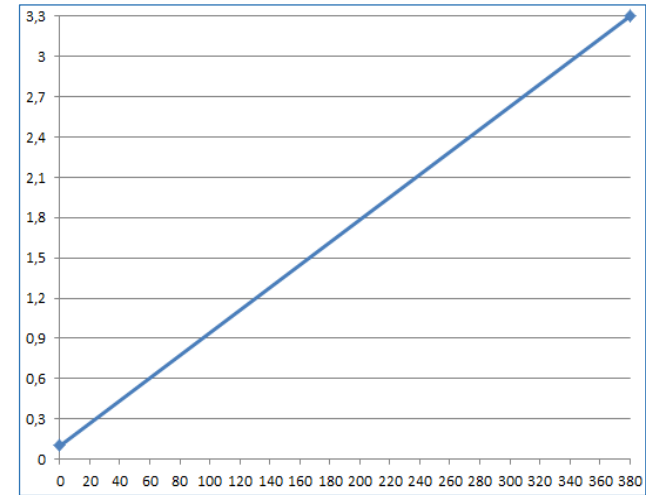

Voltage input (V) / Speed (RPM)

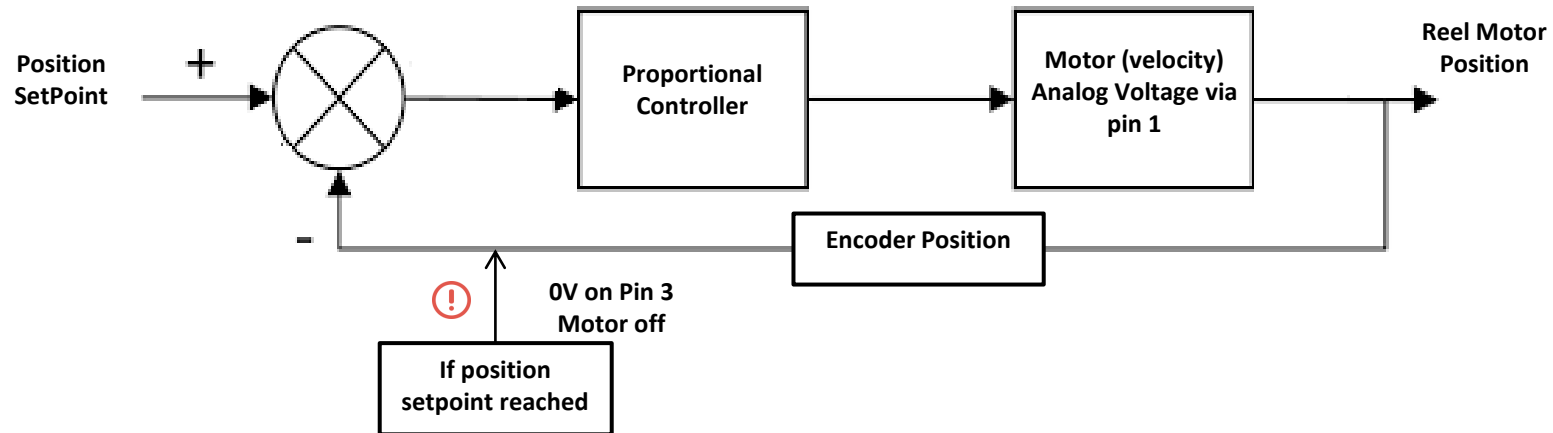

WLG-30-R with embedded encoder

Motor dimensions

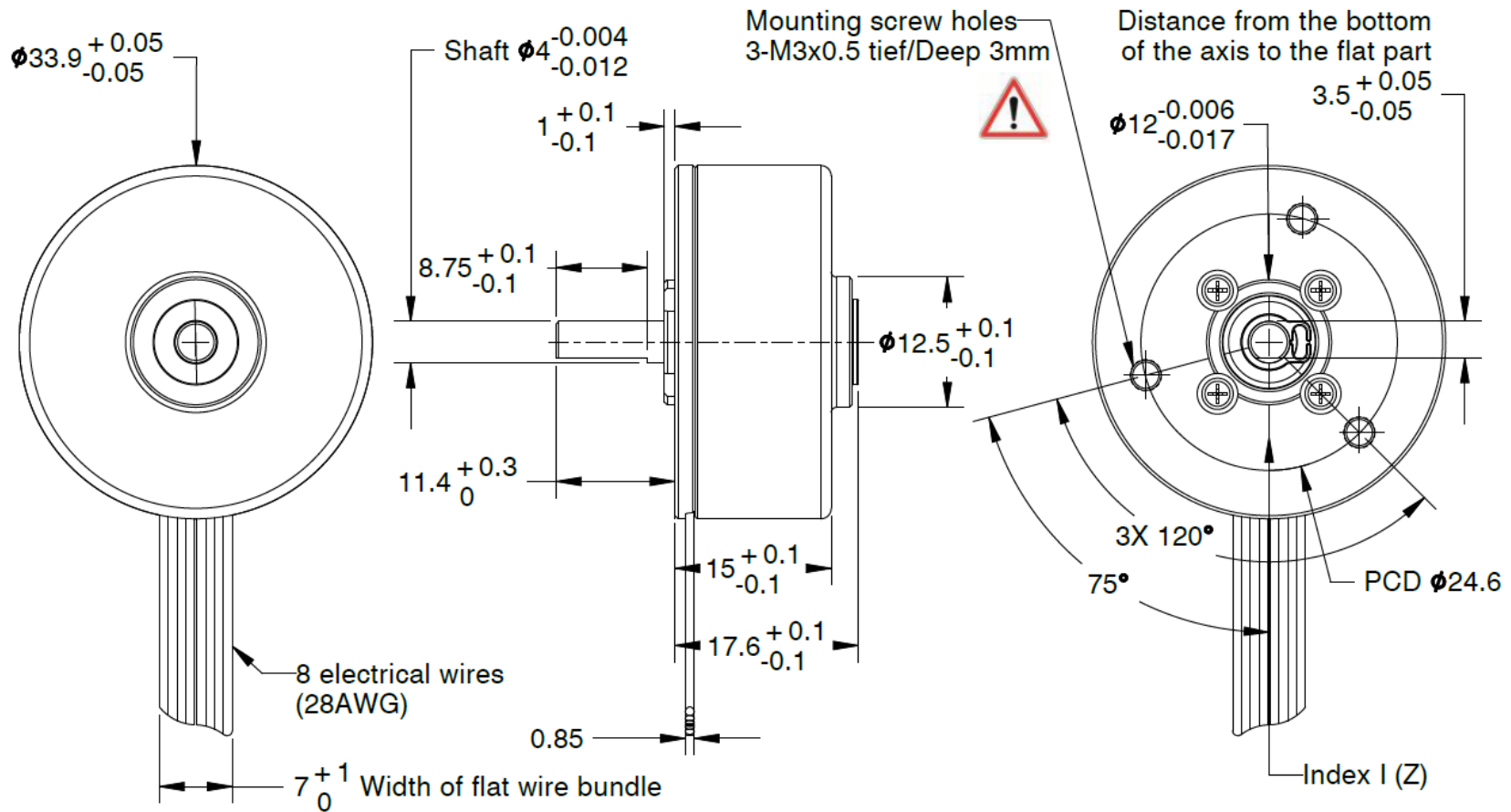



Embedded encoder:

Index I (Z) of the encoder is set perpendicular to the flat part of the driving axis, facing the 8 electrical wires.

WLG-30-R with embedded encoder

Mounting recommendation

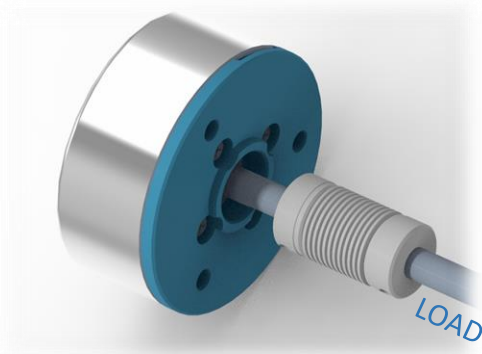

WLG-30-R motor can perfectly transmit the mechanical power required if its assembly respects two constraints

-  The motor shaft must absolutely not be loaded by radial load more than specified : 10 N
-  The motor must be mounted on cooling plate designed in order to better dissipate the heat emanating from the motor



We highly recommend to use a flexible coupling between the WLG-30 motor and the load in order to ensure performances. Please find on the table the main characteristics to respect.
(our ref : A1223 from A.C.C.&S.)

COUPLING CHARACTERISTICS	VALUES
Axial stiffness	2,2 N/mm
Recommended power supply	4,2 N/mm
Inertial torque	3,6x10 ⁻⁷ kg.m ²

 We also recommend to fix the piezoelectric motor on a metal plate to dissipate the heat generated by the motor.
 Optimal size is aluminum plate with the specified dimensions : 30 x 30 x 5 mm

 Make sure to screw the motor using the right screw length (M3x0,5 – 3 mm deep MAX in the motor)
Please respect the recommended tightening torque for M3 screws : 0,9 Nm

WLG-30-R with embedded encoder

Control specifications

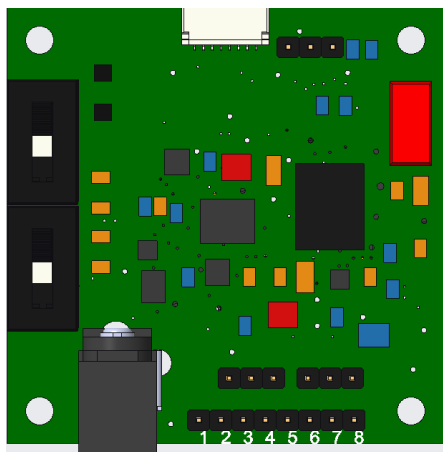

ECU pins identification

PIN	INPUT / OUTPUT	SPECIFICATIONS
1	I	Speed control using analog voltage 0 – 3,3 VDC
2	-	Ground
3	I	On Off digital control TTL level signal (0 or 5 VDC)
4	I	CW / CCW digital control TTL level signal (0 or 5 VDC)
5	O	Incremental encoder signal A (2000 increments per rotation)
6	O	Incremental encoder signal B (2000 increments per rotation)
7	O	Incremental encoder index
8	-	Not used

JUMPER CONFIGURATION			
Switch control		Eternal control (Pin 3 & 4)	
JP I/O	JP_CW/CCW	JP I/O	JP_CW/CCW

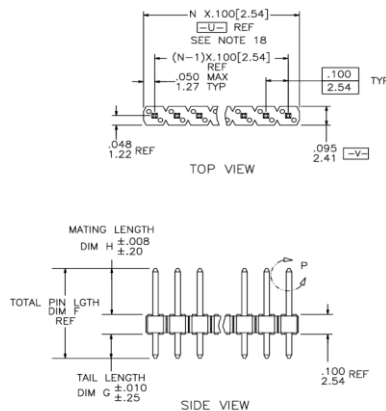

Pins dimensions

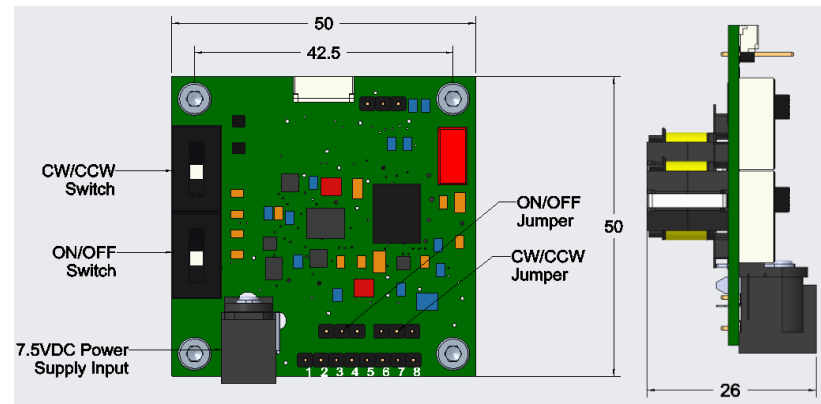

Board dimensions