

Getting started

*Thank you for trusting Tekceleo and buying this piezoelectric motor.
Please follow the instructions below before using this WLG-20-R-AMAG motor*

Inside the box

- WLG-20-R-AMAG
- WLG-20 ECU
- US adapter plug
- 9V 2A Power Supply

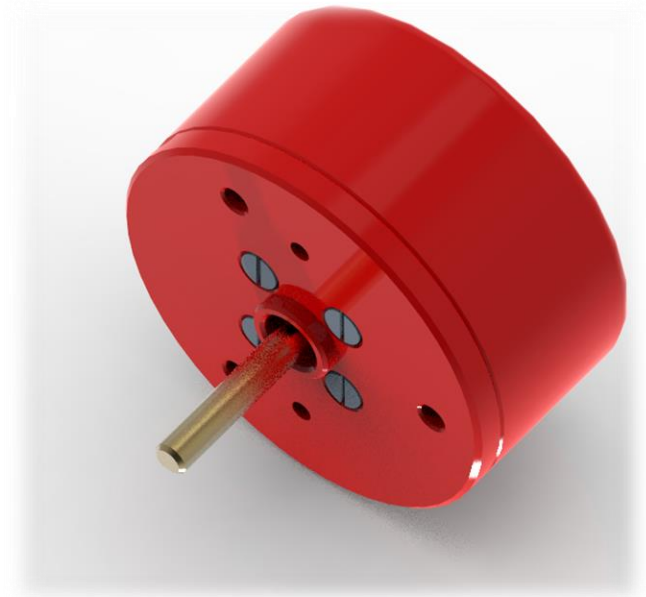

Power Up

Connect the power supply into an electrical outlet.

Motor Control

In order to turn on/ turn off the motor, activate the **on/off Switch** (*ON/OFF*).
To change the direction of the rotation, activate the **CW/CCW Switch** (*DIRECTION*)
(See figure 1).

Speed Control

In order to control the speed and turn on the motor, connect the ground pin 2 and the speed pin 1 to a voltage generator (See the figure 2 and 4). If the speed pin is not connected, the motor will not rotate.

Jumper Settings

In order to control the motor via the manual switches, place the jumpers in the **Switch Control** position (see figure 3).
In order to control the motor via pin 3 and 4, place the jumpers in the **External Control on pins 3 and 4 position** (see figure 3 and 4).

Technical specifications

MOTOR DATA WITH EMBEDDED ENCODER	VALUES
Max No load speed	380 RPM
Stall torque	25 mN.m
Rated speed at maximum output	295 RPM
Rated torque at maximum output	21 mN.m
Holding torque	40 mN.m
Maximum power	0,65 W
Operating temperature	0°c to 45°c
MECHANICAL DATA	VALUES
Max radial load, 5mm from flange	5 N
Max axial load dynamics	1 N
Max force for press fits (static, shaft supported)	18 N
Shaft concentricity	± 0,2 mm
Weight	14 g
8 Electrical wire length	0,3 m
MECHANICAL DATA	VALUES
Maximal power consumption	9 VDC / 0,8A
Recommended power supply	9 VDC / 2A

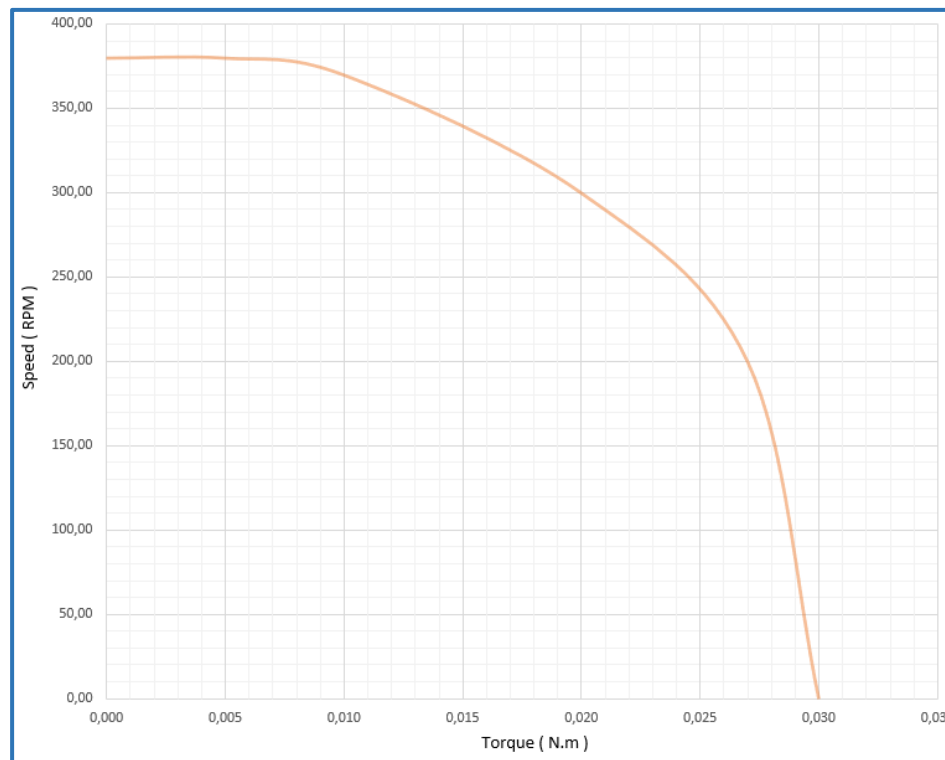

 To operate continuously, the motor needs to dissipate heat. It is advisable to mount it on a metal cooling plate. Performances are ensured as long as the temperature of the motor remains under 45 degrees (see details page 5)

Low speed control :

-  - The minimum speed has to remain above 30 rpm in order to maintain velocity and torque performances
- For speed under 30 rpm the torque vs velocity performances are not guarantee

Control specifications

CHARACTERISTICS	VALUES
On / Off response time (Pin 3)	< 500 μ s
Speed change response time	< 50 ms
Closed loop position controller (see figure below)	P control proportional
<p><u>In case you need to control the position of the motor :</u> In order to take advantage of the on / off response time of the motor, it is preferable to send a 0V on pin 3 once the motor has reached its position (see figure below)</p>	
ENCODER DATA	VALUES
Two channel quadrature digital outputs for direction sensing : A and B	1440 increments per revolution each
One channel, Index digital output I (Z)	1 increment per revolution

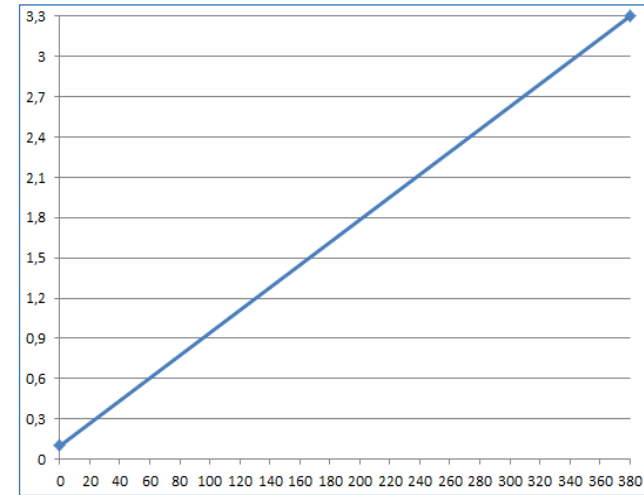

Voltage input (V) / Speed (RPM)

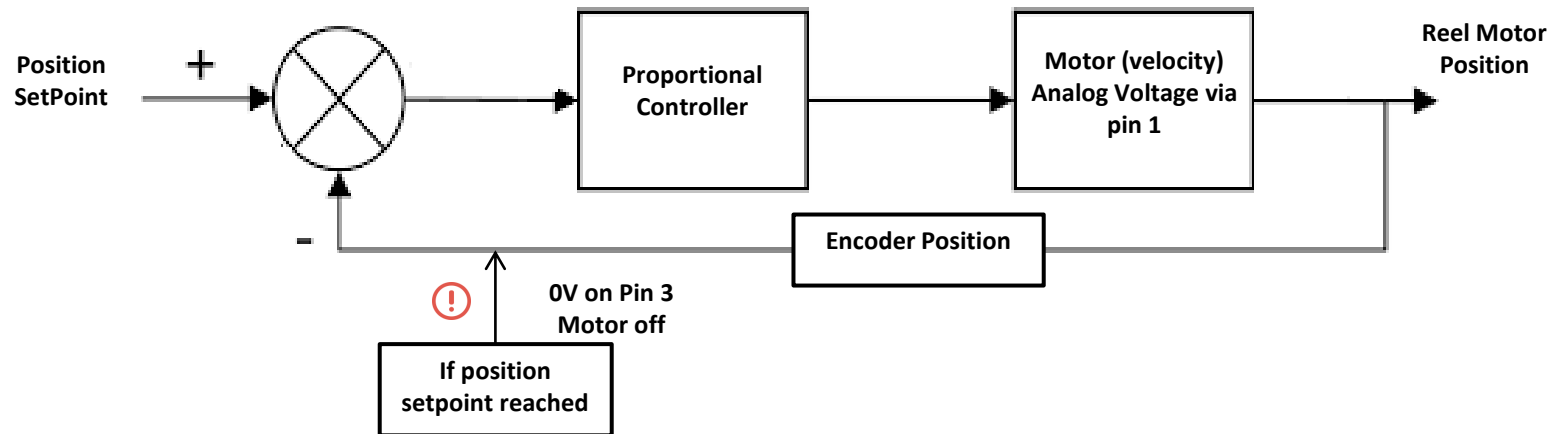

WLG-20-R-AMAG with embedded encoder

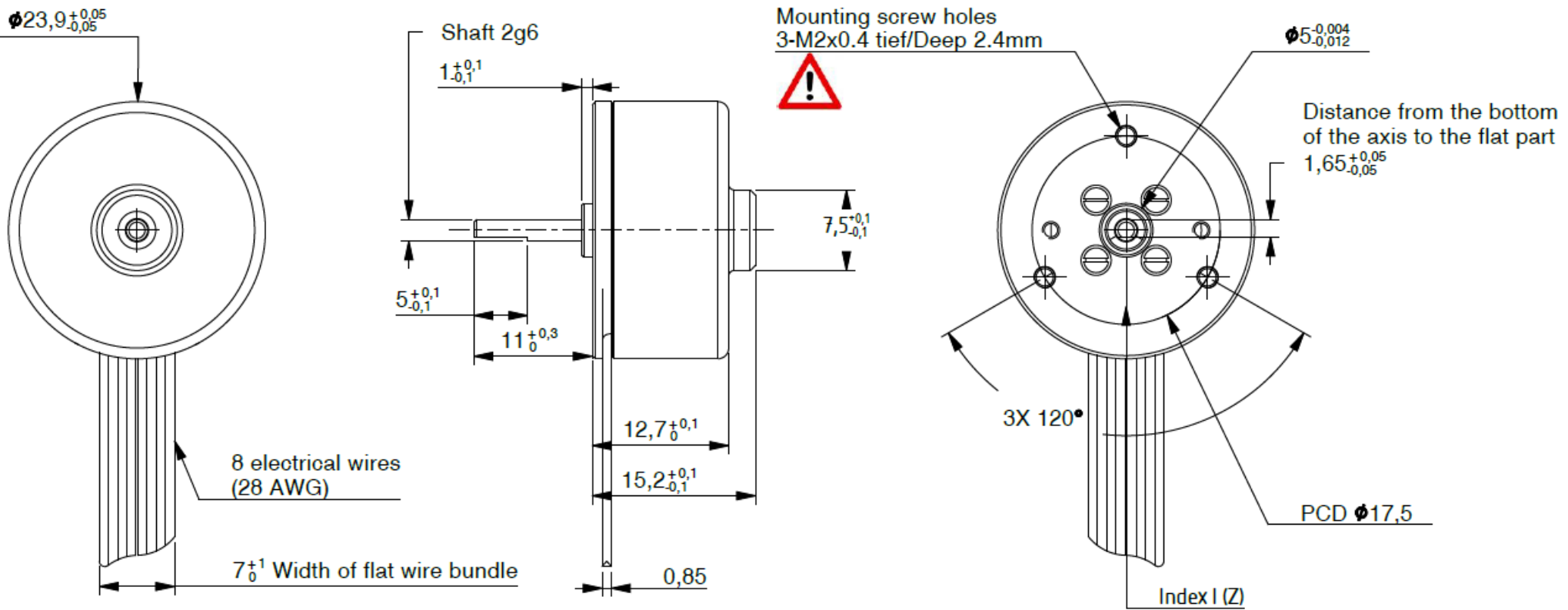

Motor dimensions



Embedded encoder:
 Index I (Z) of the encoder is set perpendicular to the flat part of the driving axis, facing the 8 electrical wires.

Mounting recommendation



WLG-20-R-AMAG motor can perfectly transmit the mechanical power required if its assembly respects two constraints

-  The motor shaft must absolutely not be loaded by radial load more than specified : 5 N
-  The motor must be mounted on cooling plate designed in order to better dissipate the heat emanating from the motor



We highly recommend to use a flexible coupling between the WLG-20 motor and the load in order to ensure performances. Please find on the table the main characteristics to respect.
(our ref : A 1223 from A.C.C.&S.)

COUPLING CHARACTERISTICS	VALUES
Axial stiffness	2,2 N/mm
Radial Stiffness	4,2 N/mm
Inertial torque	3,6x10 ⁻⁷ kg.m ²

 We also recommend to fix the piezoelectric motor on a metal plate to dissipate the heat generated by the motor.
 Optimal size is aluminum plate with the specified dimensions : 30 x 30 x 5 mm

 Make sure to screw the motor using the right screw length (M2x0,4 – 2,4 mm deep MAX in the motor)
Please respect the recommended tightening torque for M2 screws : 0,3 Nm

WLG-20-R-AMAG with embedded encoder

Control specifications

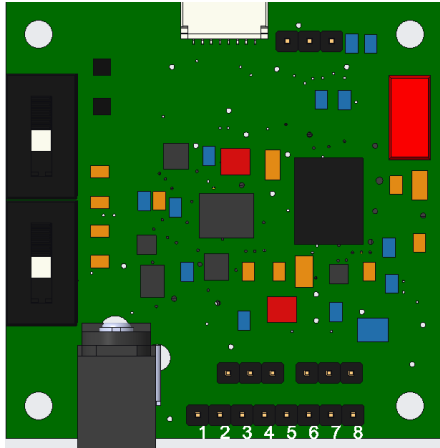

ECU pins identification

PIN	INPUT / OUTPUT	SPECIFICATIONS
1	I	Speed control using analog voltage 0 – 3,3 VDC
2	-	Ground
3	I	On Off digital control TTL level signal (0 or 5 VDC)
4	I	CW / CCW digital control TTL level signal (0 or 5 VDC)
5	O	Incremental encoder signal A (1440 increments per rotation)
6	O	Incremental encoder signal B (1440 increments per rotation)
7	O	Incremental encoder index
8	-	Not used

JUMPER CONFIGURATION			
Switch control		Eternal control (Pin 3 & 4)	
JP I/O	JP_CW/CCW	JP I/O	JP_CW/CCW

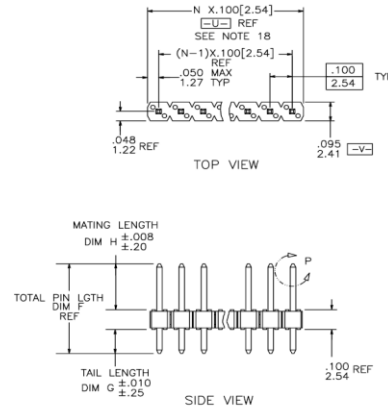

Pins dimensions

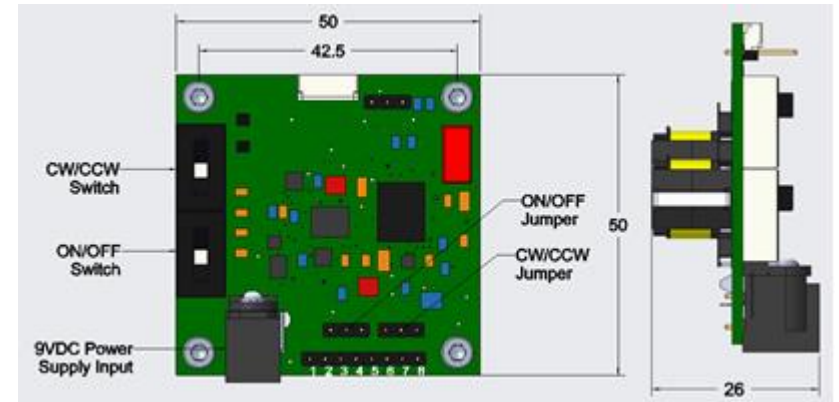

Board dimensions